

Crystal Oscillators

VCXO/3.3V/SMD/9*7*2.7mm

148.351648MHz/3.3V/APR±50ppm/AS14835VFA

特長

周波数可変範囲: APR±50ppm/Vc=1.65V±1.65V

周波数安定度: ±50ppm/-20~70, Vdd=3.3V±5%

低消費電流: 20mA/148MHz/3.3V

動作電圧範囲: 3.3V±5%

動作温度範囲: -20~+70

セラミックパッケージ(9×7×2.7mm)

Features

Frequency Deviation Range

Frequency Stability: ±50ppm

Low Power Consumption: 20mA/3.3V

Operating Voltage: 3.3V±5%

Operating Temperature: -20~+70

Ceramic Package (9×7×2.7mm)

電気的特性 Specifications

項目 ITEM	型名 TYPE	AS14835VFA
Output Frequency 出力周波数		148.351648MHz
Absolute Pulling Range(= Pullability- Stability) 絶対周波数可変範囲 (= 周波数可変幅 - 安定度)		±50ppm min/Vc=1.65V±1.65V
Frequency Stability 周波数安定度		±50ppm max/-20~+70 /3.3V±5%(Initial Deviation at 25 included, Vc=1.65V, Vdd=3.3V)
Frequency Stability/ Power Supply Voltage 電源電圧周波数変動		±9.0ppm max/3.3V±5% (Reference at 25, Vc=1.65V)
Frequency Tuning Voltage Range 公称周波数設定電圧偏差		Vt=1.65±0.16V/VDD=3.3V/25±2
Operating Temperature Range 動作温度範囲		-20~+70
Storage Temperature Range 保存温度範囲		-40~+85
Power Supply Voltage 電源電圧		+3.3V±5%
Power Consumption(No Load) 消費電流(無負荷)		typ:20mA/3.3V, max:26mA/3.3V
Output Symmetry 出力波形対称性		45% to 55%(at 1/2VDD)/3.3V/25
Rise Time/Fall Time 立ち上がり、立ち下がり時間		4.0nS max(0.3~3.0V)/4.0nS max(3.0~0.3V)
Output Load 出力負荷		15pF
Input Level 入力レベル		V _{IH} :+3.0V min/V _{IL} :+0.3V max
Output Level 出力レベル		V _{OH} :+3.0V min/V _{OL} :+0.3V max
Assembly Temperature Range 実装温度条件		Peak Temperature 240±5 for 5seconds max.Maximum Temperature:245

推奨半田付け条件 / Recommended Reflow Soldering Condition

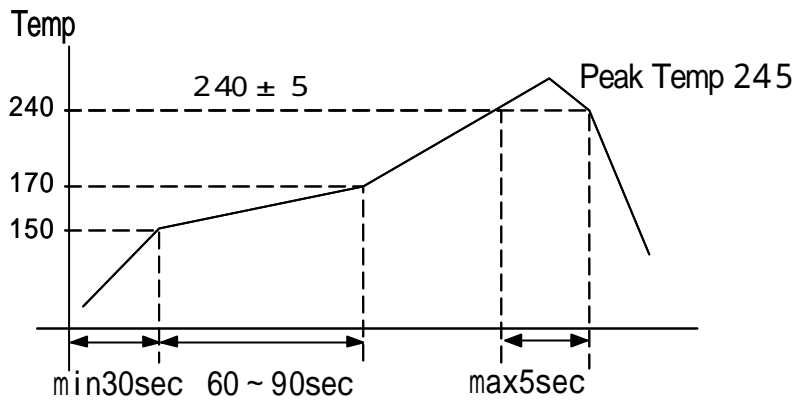

測定回路 Measurement Circuit

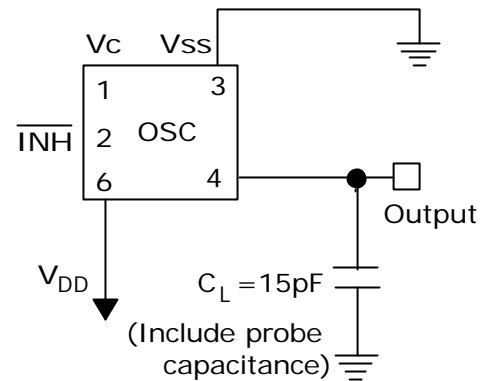

外形寸法 Dimensions

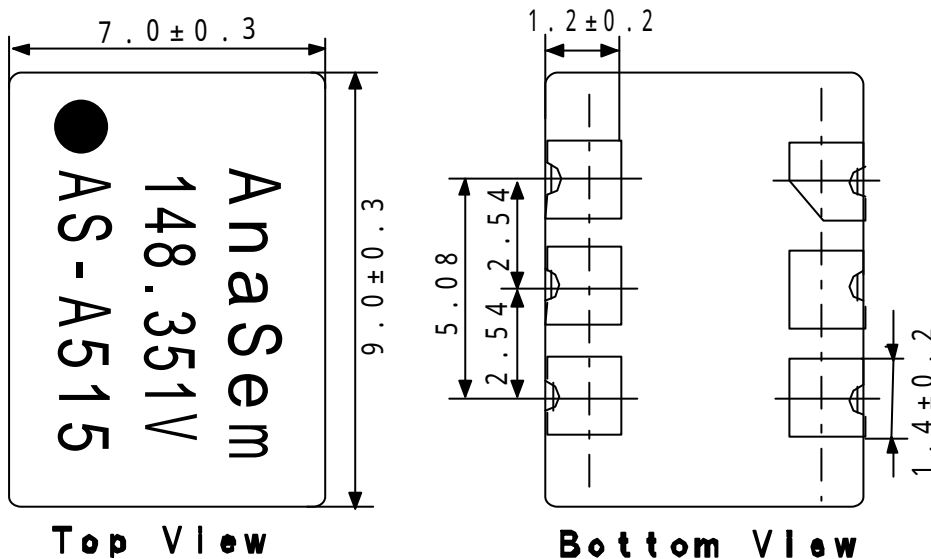

接続端子 Pin Connections

Pin Connections

	V _c
	$\overline{\text{INH}}$ (Tri-State)
	GND(V _{ss})
	OUTPUT
	NC
	V _{DD}

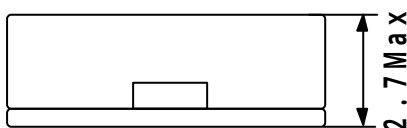

(Unit: mm)

/ INHIBIT	
"L" Level	Open or "H" Level
High Impedance	Enable: Output

マーキング Marking

AS - A515

↓ ↓ ↓
a b c

a	Maker / ID: AS=AnaSem. InC
b	Product Version/A: A Version
c	Production Week&Year: 515/15th week/2005

製造元: アナセム株式会社

Maker : Ana Sem Inc

〒274-0825 船橋市前原西2丁目13-10

2-13-10 Maehara Nishi Funabashi Chiba Japan

TEL (047) 470-5810 FAX 470-5825

Home Page: <http://www.anasem.co.jp>

e-mail: support@anasem.co.jp